

# AUTOMATIC DETECTION and TRACKING for the SAN FRANCISCO VESSEL TRAFFIC SYSTEM

J. L. MacArthur, J. M. Davis, and S. F. Oden

*The Automatic Detection and Tracking subsystem for the San Francisco Vessel Traffic System consists of a Radar Video Preprocessor (RVP) and a Radar Computer. The RVP operates on radar logarithmic video to accomplish adaptive threshold detection, binary integration, and formatting of hits for entry into the Radar Computer. Radar Computer functions include scan-to-scan correlation of RVP detection reports to acquire and enter new contacts into the system and track filtering to develop smooth position and rate data on up to 253 ships and buoy contacts.*

## Introduction

**T**HE SAN FRANCISCO EXPERIMENTAL VESSEL Traffic System (VTS) is an all-weather radar/communications/computer/display complex developed for the U. S. Coast Guard. Two radars are associated with the system, one at Pt. Bonita (PTB) and one at Yerba Buena Island (YBI) to provide coverage of the seaward approach and the inner bay. Associated with each radar is an Automatic Detection and Tracking (ADT) subsystem that develops position, speed, heading, and size data on vessel contacts operating in the harbor. Information developed in the ADT subsystem is then sent to a Traffic Analysis and Display (TAD) subsystem where contacts are displayed and system operations are carried out via an interactive graphics display. The ADT subsystem performs the basic surveillance function in the radar coverage regions of the VTS.

Each ADT subsystem consists of a Radar Video Preprocessor (RVP) and a Radar Computer (Honeywell DDP-516R) (Fig. 1). The function of the RVP unit is to perform threshold detection, moving window binary integration, and formatting of radar hits for entry into the Radar Computer. The RVP incorporates several unique design features related to signal processing in a sea clutter environment and track centroid estimation in a high resolution system. Each RVP con-

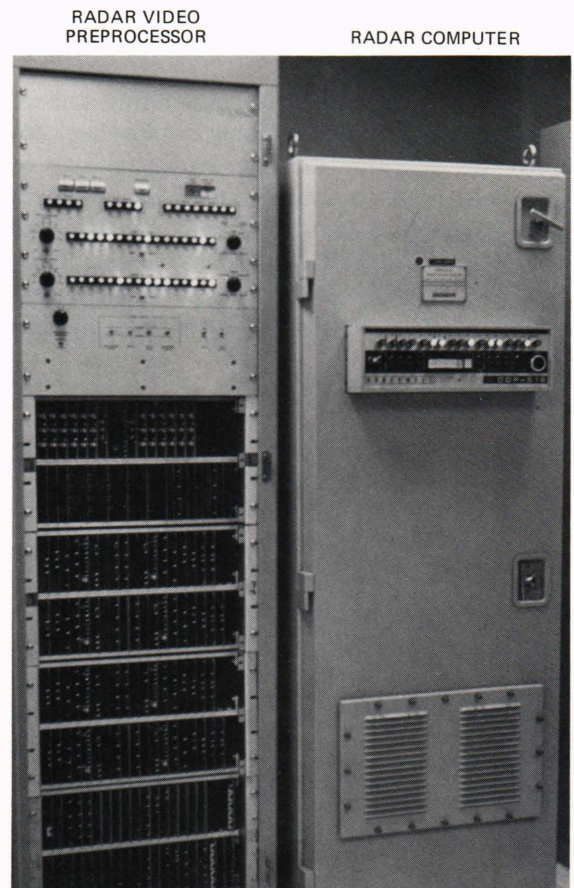

Fig. 1—Automatic detection and tracking subsystem.



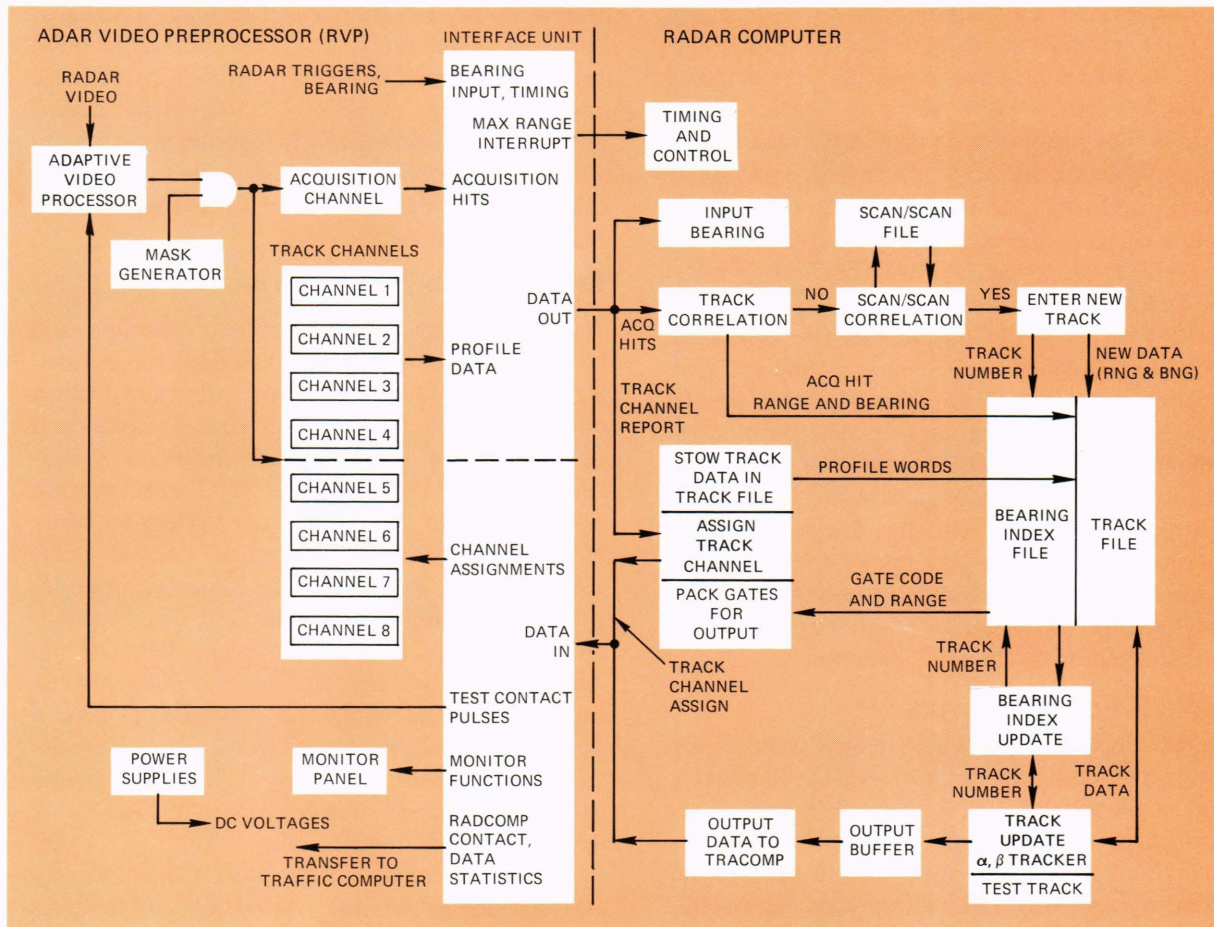

Fig. 2—Block diagram of automatic detection and tracking subsystem.

tains some 1800 integrated circuits, with about 40% of the medium scale integration (MSI) type. Functions performed in the Radar Computer include scan-to-scan correlation of RVP detection reports to acquire and enter new contacts into the system, adaptive filtering based on maneuver sensing to develop smooth position and rate data, range-bearing gate size variation to adapt to vessel size differences, and contact size calculation based on the extent of the video returns in the gates. The Radar Computer efficiently utilizes an 8,192 word memory in a program which had as a starting point the results of previous developments in related radar detection systems for the U. S. Navy.

Data on each vessel in firm track are passed to the TAD subsystem via an interface in the RVP once each 3-second azimuth scan. Buoys receive special attention in that their nominal positions are "pre-stored" in the computer track file so that

they do not undergo the normal acquisition. Reports to the Traffic Computer indicate whether the tracked position of any buoy differs from the nominal position by more than the radius of a selected watch circle.

The ADT subsystem and its major functional modules are depicted in Fig. 2. Radar logarithmic video is first converted from a wideband analog signal into a wideband digital signal representing initial detections by using an adaptive thresholding technique with an adjustable sensitivity. Detections are applied to an acceptance mask that restricts coverage to deep water regions of interest. New detections are processed in an acquisition channel that consists of a moving-window binary integrator implemented in 25-foot range cells to a maximum of 15 nmi. If any acquisition channel report does not fall within a range-bearing gate generated by a contact already in track, the hit will be reported to the computer. Track initiation



in the computer will require a hit to be received on three successive azimuth scans within the same 300-foot x 2.8° range-bearing cell resulting in the generation of a tentative track. These tracks will be processed via the RVP Track Channels on subsequent scans to develop smoothed position and rate estimates. After an appropriate number of scans has elapsed and hits continue to be received, promotion to Firm Track and TAD reporting will commence. The Track Channels in the RVP provide the mechanism for collecting hits within assigned range-bearing windows and for forming these into range and bearing profile words for input to the computer. The positioning of the Track Channel assignments (gates) is controlled by the computer as part of the track filtering process. The RVP also has the capability of generating two test contacts upon command from the computer that are useful in testing the ADT subsystem. A monitor panel also displays pertinent information on the RVP data flow.

### Radar Characteristics

Since the YBI and PTB radars provide the basic input data for the two ADT subsystems, their characteristics are presented briefly here. Specifications for the radars procured for the Vessel Traffic System were influenced in part by the special needs of the automatic processing system. The two main considerations in the choice of radar parameters were detection in clutter and resolution of closely spaced contacts, where the basic radar resolution "cell" is established by the pulse width and antenna beamwidth. A narrow pulse width of 50 nanoseconds represented a practical limit set by what could be achieved reliably from existing designs. An antenna beamwidth of 0.3° was specified to permit detection of small contacts in clutter by the PTB radar, and to resolve passing contacts in narrow sea lanes seen radially by the YBI radar.

Antenna polarization of the two radars may be switched between linear and circular. Typically, the YBI radar uses horizontal polarization, while vertical polarization is employed at PTB to provide some advantage in higher seas. Circular polarization is provided to improve performance in rainfall.

Radar triggers and 14-bit parallel bearing words (least significant bit = 0.022°) from both radar subsystems are sent to the two appropriate RVP units for processing; these data are also

routed to the operational PPI displays associated with the manual system. Three selectable pulse repetition rates (PRR) are provided in the basic radar subsystem. A PRR of 2,500 per sec is used with the ADT subsystem; for an antenna rotation rate of 20 revolutions per minute this means that about six hits per radar scan should be received from a point contact.

### Initial Video Processing

The first step in the automatic detection and tracking process is that of extracting radar video signal returns of desired ships and buoys from a background of internally generated noise and reflections from the sea. This detection is performed by the Adaptive Video Processor portion of the RVP. In a manual radar system an operator recognizes detections when isolated point returns extend above the local noise background, producing a bright blip on his PPI display. Similarly, the adaptive processor must decide if the video content of any one range resolution cell represents a real contact by comparing it to a sample of the local environment. This comparison is made possible by using a tapped delay line as a video storage device (refer to Fig. 3). A delay line with a radar range "length" of 1,000 feet was chosen, with video taps available every 50 feet down the line. A set of comparators makes continuous decisions as the video propagates down the line. Each comparator produces

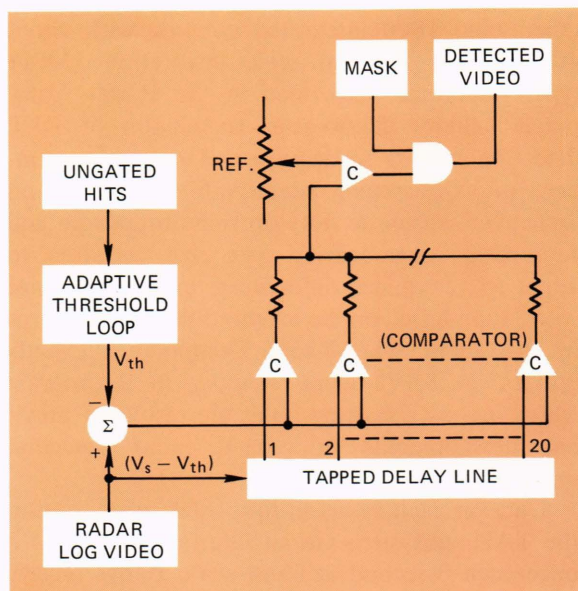

Fig. 3—Adaptive video processor.



an output whenever the video at its tap is exceeded by the video signal at the delay line input, less a variable threshold voltage  $V_{th}$ . It may be seen that the relative magnitude of  $V_{th}$  directly affects the probability that a video sample at the line input is a real contact of reasonable size. Thus the detection sensitivity of the processor is a function of this threshold voltage. The digitized comparator outputs are summed to form a composite signal whose amplitude is a measure of how well the input video sample rises above its near environment. One advantage of this scheme is that large, isolated clutter spikes at delay line comparison taps cannot raise the threshold excessively and thus desensitize the detection process. A final comparator produces a detection output whenever the summation signal exceeds a selected reference voltage, or "majority vote" level. Proper selection of this level reduces the self-inhibiting of large contacts due to saturation of the delay line.

The variable threshold voltage  $V_{th}$  which is subtracted from the signal video is developed in an adaptive threshold loop using the results of subsequent processing in the RVP. Basically, this voltage is adjusted automatically until a selected number of acquisition "hits" per azimuth scan (i.e., ungated contacts not being tracked by ADT) are being reported to the Radar Computer. Several values of hit count/scan are available to the system operator to vary sensitivity. Assuming that most real contacts are being tracked automatically, this hit count should then represent random, uncorrelated detections, thus providing a selectable constant false alarm rate for the ADT subsystem.

It may be noted that the Adaptive Video Processor is essentially a one-dimensional detection device; that is, its decision that a contact is present in a particular range cell is based on comparison with other cells distributed in range at a single azimuth, or for each radar transmission. There is then no memory of hit patterns from one transmission to the next as the antenna scans past a tentative contact. Hits from the Adaptive Video Processor must therefore be examined further by additional hardware and software processing.

## Geographical Mask Generation

One necessary requirement in an Automatic

Detection and Tracking system is that only video returns from regions of interest be introduced into the processing stream. Accordingly, the Radar Video Preprocessor includes a digital mask generator which inhibits returns from land areas, shallow water areas, and all areas beyond the system maximum range of fifteen miles.

Examination of the regions of interest in the YBI radar coverage area indicated that the desired mask could be implemented by providing two enable zones along any bearing line, while a single zone would suffice for most of the PTB coverage area. This is, after an initial inhibit zone for land near the radar site, two independent enable zones with an intervening inhibit zone (e.g., for Alcatraz Island) proved adequate. The desired mask enable regions were established as shown in Fig. 4. Basically, the start or stop range of an enable zone in a particular place is derived from a read-only memory which is addressed by special bearing sector gate functions decoded from the radar bearing word. An azimuth resolution of  $0.703^\circ$  is provided for derivation of these special bearing sectors. In many cases, the range to the leading or trailing edge of an enable zone does not change for many degrees, allowing use of a single word from the memory for that zone edge. The memory words, which contain the start/stop ranges in binary digital form, are used in mask generator counting logic to develop the composite real-time mask enable/inhibit gate signal, which has a 25-foot range resolution. This mask signal is sent to the output stage of the Adaptive Video Processor described earlier, where it gates the digitized video pulses that have passed the threshold and "majority vote" detection criteria.

For ease of modifying the mask in the field, memory units were selected that could be reprogrammed rapidly. Because of the relatively slow bearing signal rates involved, peg-board matrix memories with diode pins inserted at appropriate X/Y crosspoints were adequate. An additional feature was included in the YBI mask generator to minimize memory size requirements. Wherever possible a single increment range word is used to slowly step the mask edge in or out in range over a given bearing sector. This technique allows the mask to closely follow critical areas such as bridges and harbors without an excessive number of separate memory words.



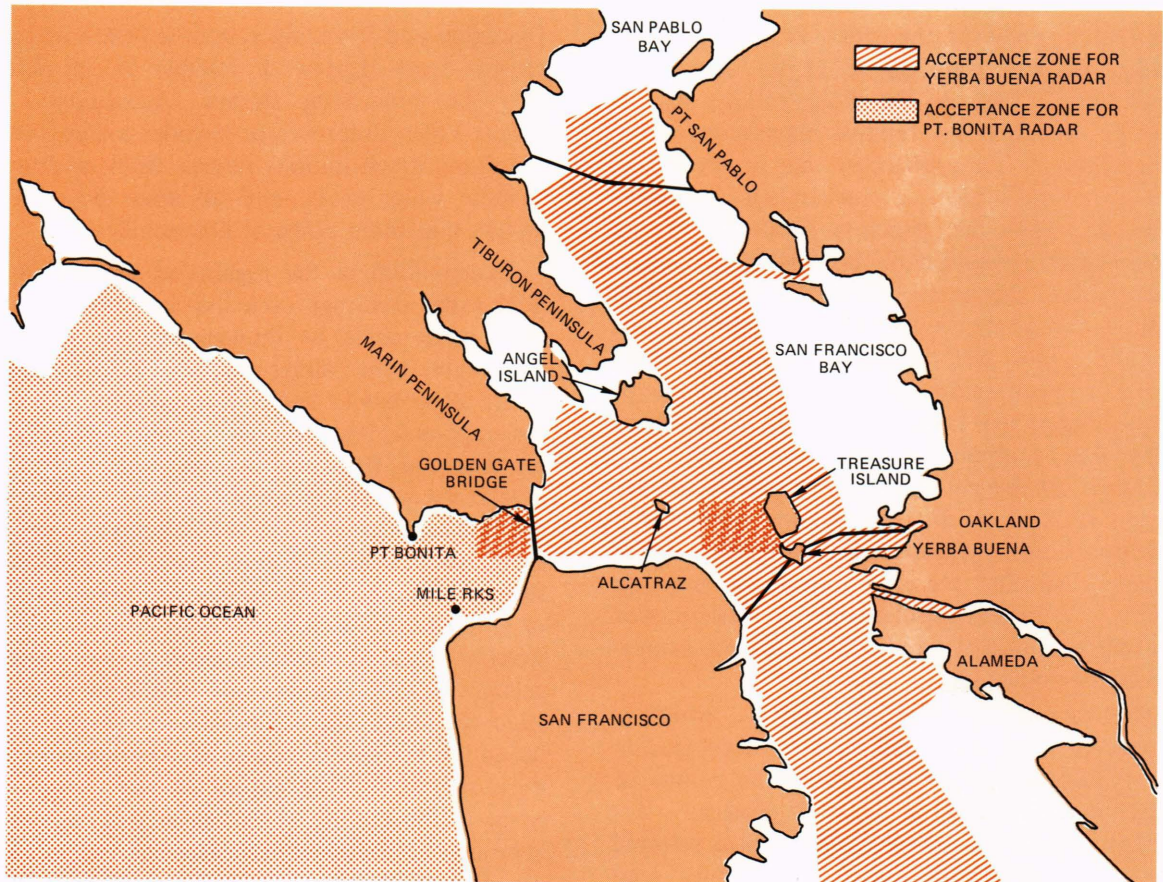

Fig. 4—Automatic detection and tracking mask outlines.

### Acquisition Processing

Radar range and bearing resolution is such that for each antenna scan past a vessel contact, a cluster of multiple detections will occur in the Adaptive Video Processor, distributed in both range and bearing. These multiple hits (gated by the geographical mask) are collected by the RVP Acquisition Channel, which performs additional detection processing and generates single detection reports to the Radar Computer. Hits are collected in bearing in a "moving-window" binary integrator which examines each 25-foot range resolution cell over six successive radar transmission periods or dwells (equivalent to the antenna beamwidth). A detection will be declared in a range cell if hits occur in at least four of the six successive dwells. A large storage capacity is required to implement this detection criterion for each range cell over the system range of fifteen nautical miles. Because of this and the 20 MHz video rate of detections arriving at the Acquisition

Channel, a multiplexing scheme is used to permit slower processing (refer to Fig. 5). Detection data are shifted into the channel at 20 MHz and then shifted down the multiplexed storage chains at a slower rate. Detection devices then examine each cell in turn, declaring hits whenever the four out of six hit criterion is met.

Precise position information on a new detection report to the Radar Computer is not required since this is determined by subsequent processing during automatic tracking. Therefore, the detection results at full resolution from the twelve binary integrator chains are combined into two groups of six; a slower clock then multiplexes these two coarser results to form a final synthetic video output. A detection in any 25-foot range cell will generate a quantized synthetic video pulse, and will be reported to the RVP computer interface with a 150-foot range resolution. Actually, two synthetic video signals are generated. One output for display on system PPIs is pro-



duced each radar dwell (pulse repetition period) as long as that detection is present in the Acquisition Channel. Then, when the contact disappears from view, loss of detection sends a single pulse to the RVP/computer interface where it generates a data interrupt to the Radar Computer unless that contact is already in automatic track. A single word is then sent to the computer which gives the approximate range of the contact.

The acquisition channel-report-computer processing consists of the following steps:

1. Each acquisition report is tested for correlation with existing New Tracks. If there is correlation, the report is entered in the track file under that track number for later track prediction.

2. If there has not been a New Track correlation, a scan-to-scan correlation is performed on the report. If there is correlation with a previous scan's report, a New Track is entered in the track file. If there is no correlation, the acquisition report is entered in a scan-to-scan file. The scan-to-scan correlation bin size is 300 feet by  $2.8^\circ$  out to a range of 9.6 nmi. If the report has a range greater than 9.6 nmi, it is entered directly as a New Track.

3. All old acquisition reports are removed

from the scan-to-scan file while the new uncorrelated reports are entered in the file.

## Track Processing

A track slot in the Track Data File is assigned to each New Track generated by the Acquisition Report processing. The information developed on each track consists of range, range rate, bearing, bearing rate, and various tracking and status parameters. After entry from the Acquisition Report processing, a track is promoted based on hit count as well as a measure of the maneuver activity of the track to minimize the number of false tracks resulting from sea clutter or ship wakes. A New Track that has been correlated with an acquisition hit report is promoted to the Tentative Track stage and subsequently generates Track Channel assignments to the RVP. From this point on, the input data for the track will be in the form of an RVP Track Channel report.

Use of an RVP Track Channel begins when the Radar Computer sends two assignment words via the RVP/computer interface (refer to Fig. 6). A control word sent first identifies the channel being assigned and sets the dimensions of the effective gate to be used. A Range Word then gives the binary range of the leading edge of

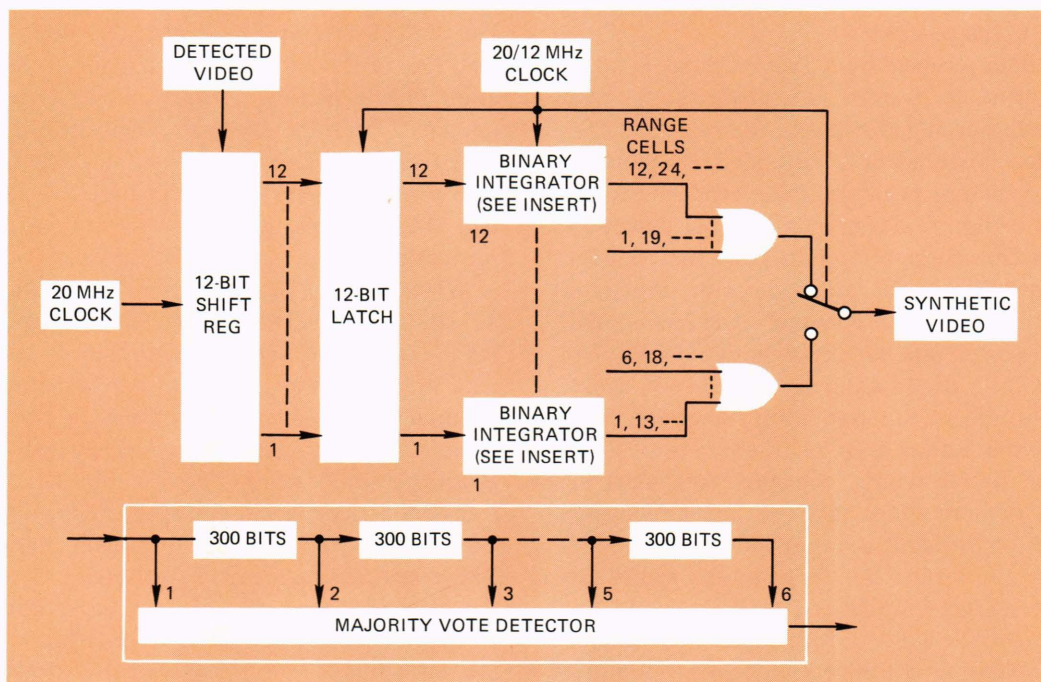

Fig. 5—Acquisition channel.



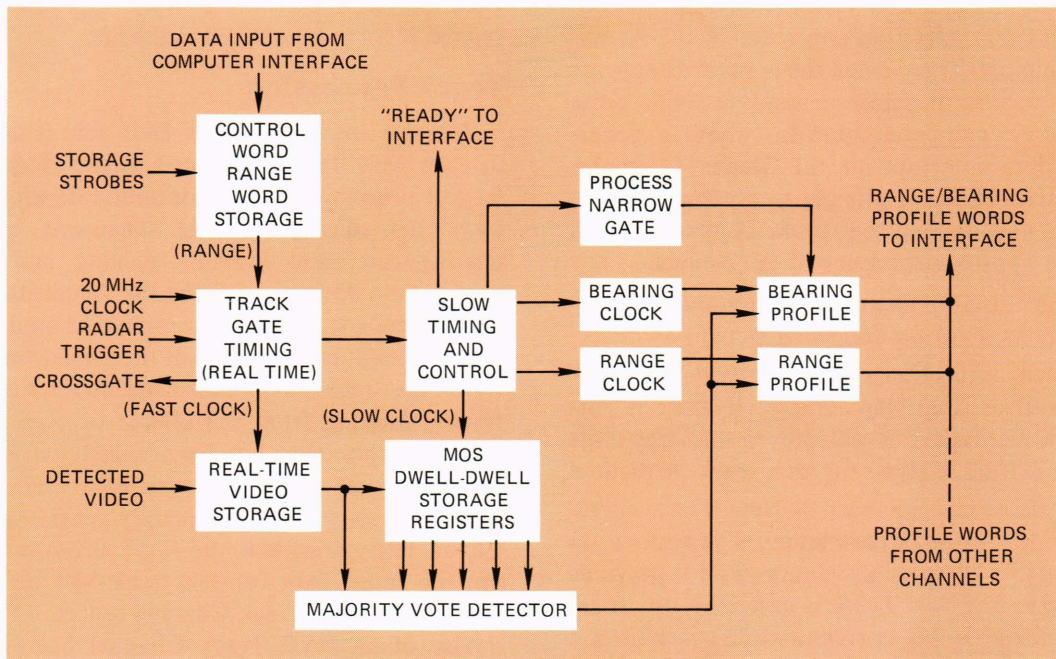

Fig. 6—Track channel.

the track gate. A channel is assigned in the “dead time” just preceding the radar transmission where tracking is to begin; the channel remains assigned, with no further data from the computer required, until all tracking data have been processed for reporting to the computer.

Video data received by a Track Channel, when its track window is open, are processed in two steps. During each radar dwell, the real-time 20-MHz video is stored in a shift register spanning the track gate size in range. (The crossgate function used to inhibit acquisition channel detection reports is derived at this point.) As the channel receives dwell-to-dwell data, a detector similar to that in the Acquisition Channel examines stored data at a slower rate over consecutive dwells. Up to this point video data from all 25-foot range cells are stored at full resolution. Since the final report to the Radar Computer consists of only two 16-bit profile words, detection data must be collapsed in both range and bearing. Obviously, resolution of the data is improved if the profiles can be formed from a limited gate area within the full size track gate, which is 1,600 feet by 12.8°. A Range Profile word is formed from a smaller area by operating a Range Clock over a limited part of the gate range timing. Possible gate sizes include 1,600, 800, or 400 feet in range. Bearing

resolution is improved by restricting the number of radar dwells over which the channel operates. A process narrow gate is used to restrict the range over which bearing data are gathered. The current bearing gate size options that are used are 0.8, 1.6, 3.2, 6.4, and 12.8° by 800, 400, or 200 feet. Use of the narrower range gates in the generation of the bearing profiles allows logic to be implemented in the event of closely spaced (merging) tracks, which in effect assumes that contacts whose narrow gates overlap cannot cross in bearing, thus allowing edge tracking to be used to prevent a transfer of track numbers.

When the tracking assignment is completed, the Track Channel sends a “Ready” signal to the RVP/computer interface to produce a computer data interrupt. The computer hardware then acts to input a three-word report from the channel: a channel ID word, the Range Profile word, and the Bearing Profile word. Upon completion of the transfer, a clear signal resets the reporting Track Channel in preparation for its next assignment. The track channel report processing branch of the program stores the three word report in the correct Track Data File. The program can then use this channel for assignment to another contact. The track is then ready for update based on the information contained in its Track Data File.



The track update consists of calculating the tracking errors from the profile words and then applying them to a set of independent range and bearing tracking filters. The filter used is the classical  $\alpha, \beta$  recursive filter which is well suited for the computerized track-while-scan system. The tracking errors, after being modified by the  $\alpha, \beta$  "damping factors," are used to form new estimates for rates and positions. Values of the damping factors,  $\alpha$  for position and  $\beta$  for velocity, are varied depending on the quality of the data and the duration of the prior track. These factors will determine the response of the system to noise and to changes in track velocity.

Smoothed position and rates for firm tracks are reported to the TAD complex following updating. Predicted range and bearing are used to position the tracking gate on the next scan. Selection of the filtering constants or the  $\alpha, \beta$  pairs is based on the maneuver counts which are adjusted according to the profile errors. If the errors are too large, the count is incremented; otherwise the count is decremented. The variable maneuver count results in a variation of  $\alpha, \beta$  pairs from  $\frac{1}{2}, \frac{1}{2}$  to  $\frac{1}{8}, \frac{1}{64}$  in range and  $\frac{1}{2}, \frac{1}{2}$  to  $1\frac{1}{2}_{250}, \frac{1}{6}_{12}$  in bearing. The maneuver counts are initialized at the highest value (largest  $\alpha, \beta$  pairs) and then only allowed to count down until an intermediate value is reached. Then the counts may increase or decrease according to the error but are never again allowed above this intermediate value. This allows the tracking loop to handle initial large errors due to acquisition, and then after acquisition to handle possible ship maneuvers. The range bias on the  $\alpha, \beta$  selection is included mainly to optimize medium and large contact tracking where the most significant maneuver is an apparent one induced by a crossing path at close range, rather than an actual ship maneuver—thus, the exception for small boats which can, in fact, maneuver. The bias is not removed for small boats in choosing bearing  $\alpha, \beta$  since the spreading of the physical extent of a given bearing gate as range increases makes it unnecessary.

There are two other functions performed during track updating based on the contents of the profile words. A coarse estimate of ship length is made by comparing and combining the appropriately scaled range and bearing profiles after subtracting the spread of a point contact ( $0.3^\circ \times 25$  feet) by the following relationship:

$$\text{Length} = \text{larger of range/bearing projection} \\ + \frac{1}{2} \text{ smaller of range/bearing projection.}$$

The length thus measured will be compared to the size in the Track File, and, if the two do not agree, the size will be changed by 25 ft (the least significant bit in range), thereby providing some smoothing to the size estimate. Length is reported to the TAD subsystem as small ( $< 150$  feet), medium (150 to 250 feet), or large ( $> 250$  feet). The contents of the profile words are also used to independently adjust range and bearing gate sizes for the next scan.

When two tracks approach closely enough for their track gates to overlap, the RVP sets a flag in the Track Channel report to the computer thereby initiating merging track processing logic. Based on the profile words, edge tracking in range or bearing is performed. The logic performs a secondary role in preventing track gates from developing on ship wakes and in minimizing the development of tracks on tide rip and sidelobe clutter.

In order to prevent detections arising from bridge structures that would interfere with ship tracking, the three bridges in the area (Golden Gate, San Francisco-Oakland, and Richmond-San Rafael) are masked out. Contacts that pass under the bridges would also be completely or partially masked, and in order to maintain smooth track continuity, special logic is required. To this end, three broad range-bearing zones are set up at the bridges, and in these zones contacts whose gates fall outside the mask at any point are flagged for modified updating logic, and in general will not be dropped from track as long as the flag is set. Basically, a contact is "coasted"; i.e., range and bearing will be updated according to past rates and the profile errors will be ignored temporarily. When a contact clears the coast zone, normal tracking recommences. Several factors exist that require a departure from the simple coast logic. The lane structure and traffic patterns are such that ships are usually in the process of turning as they pass under the bridges. Contacts passing under the San Francisco-Oakland Bridge will be essentially on tangential courses and turns will alter range-rate mainly, whereas the bearing profile will be most disturbed by the mask. Therefore, at this bridge the logic is to continue range track and coast bearing only. The reverse is true



at the Golden Gate and Richmond-San Rafael Bridges, where turns affect bearing rate mainly and the range profiles are most disturbed.

**Buoy Tracks**—A special category of track which does not undergo the normal track evolution is the buoy track. All buoy tracks are "pre-set" in the Track Data File during the program load. Upon program start-up, if the buoy is not in close proximity to other buoys or fixed points, it undergoes an acquisition procedure that consists of transmitting an 800-foot, 32-dwell track channel assignment to look for the buoy video. If video is detected in the profile word, the gate is repositioned directly on this video. After seven scans the gate is narrowed to a 400-foot, 16-dwell track gate and acquisition is complete. In cases where this acquisition process cannot be used, only the smaller track gate is used.

The buoy tracking consists of updating the position of the buoy by the least significant bit in range (3.125 ft) and bearing ( $0.011^\circ$ ) based on the sign of the errors measured from the profile words. Once the position update is complete, a test is made to see how far the buoy is from the original position. If the buoy is out of its drift tolerance (200 yards) a drift flag is set in the data to the TAD subsystem. If no video can be found in the profile words, a no contact flag is set in the data to the TAD subsystem and the buoy is reset to its initial position. If a contact merges with a buoy, the buoy position is not changed until the merge condition ceases in order to prevent erroneous buoy tracking on passing contacts.

## Program Organization

As has been described, the function of the Radar Computer program is to detect and track contacts present in the RVP video and to provide contact reports to the Traffic Analysis and Display (TAD) system. The processing in the Radar Computer can be conveniently broken into three levels: (a) first-priority processing, or those tasks that must be accomplished on a dwell-by-dwell (microseconds) basis; (b) second-priority processing, or those tasks that must be performed after a period of several dwells (milliseconds); and (c) third-priority processing, or those tasks that must be accomplished in 3 seconds (one azimuth scan).

Program operation is controlled by two executives: a Principal Executive which controls third

priority tasks, and an Interrupt Executive which controls first and second priority tasks. Figure 7 is a simplified flow chart of the program executives. Calls to all other routines as well as the Radar Computer data flow are controlled by these routines.

Upon program start-up, a routine is executed which initializes the program parameters and synchronizes the program to the radar. The program then cyclically loops through the Principal Executive which has the main function of controlling the track updating or prediction based on the RVP input data. The Principal Executive maintains a list of all tracks in exact order of bearing in a Bearing Index File thereby maintaining synchronization of the track update with the radar bearing advancement. Tracks selected for update lag the radar bearings by at least  $28^\circ$  to insure that the RVP data of the radar sweep has been associated with the tracks (an Interrupt Executive function) prior to update.

With each radar transmission, an interrupt is

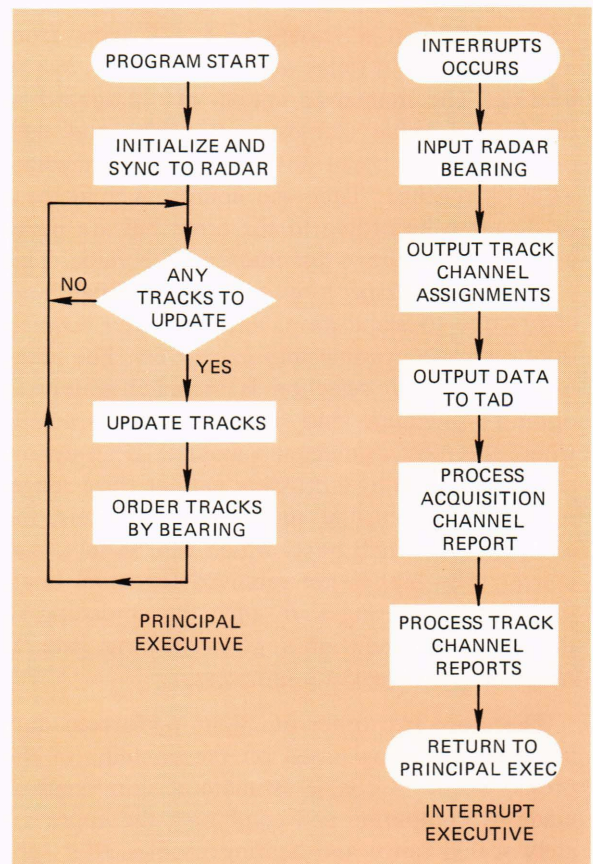

Fig. 7—Simplified program flow chart.



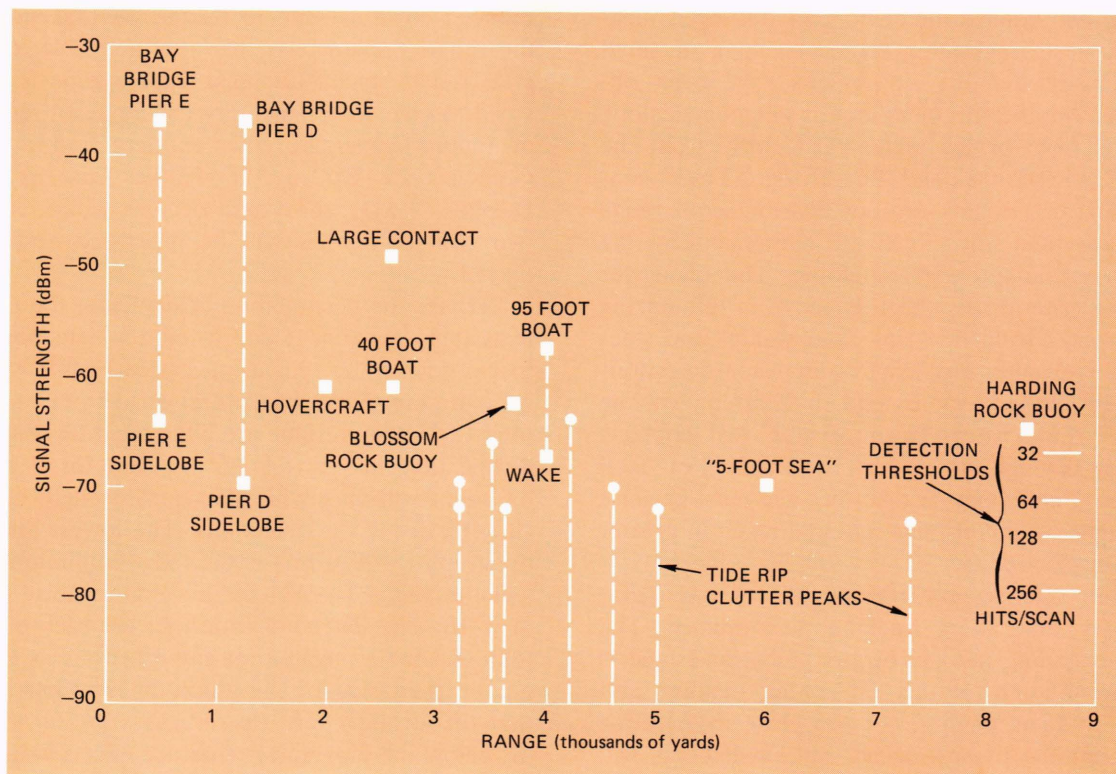

Fig. 8—Signal strength returned from various objects.

generated to the program at the occurrence of the radar maximum range ( $R_{max}$ ) trigger. This interrupt causes the suspension of third priority processing and entry into the Interrupt Executive, which controls first and second priority tasks. The first priority processing, input/output and track channel assignment preparation, is completed during each radar dwell. The second priority processing, track channel report processing and acquisition channel report processing, may take several dwells to complete. Therefore, the Interrupt Executive checks the status of the second priority processing so that the proper path is taken through the Interrupt Executive when the processing is incomplete. Both the track channel report processing and the acquisition channel report processing use double buffering to expedite input/output (I/O) and processing. Switching of the buffers and processing of the new sets of track channel or acquisition reports are not initiated until the processing for the previous sets is completed. Upon completion of these tasks, control is returned to the Principal Executive.

## System Performance

The mix of contacts presented to the ADT system spans a range from small boats and buoys of a few square meters cross-section to large ships of hundreds of square meters cross-section and over 1,000 feet long. Tracking of medium and large contacts has been consistent and reliable. Provision has been made to alert the system operator when an identified contact is involved in a potentially troublesome situation, including loss of detection, merges, and bridge coasting. Automatic acquisition has not been a problem; detection of small contacts and rejection of clutter, including that seen from Pt. Bonita, has been achieved.

Distributed sea clutter returns have not presented a problem to the Adaptive Video Processor, except when small contacts may not be detected in severe clutter. Of more concern is tide rip clutter, a localized wavelike phenomenon caused by tidal currents. Signal strength returned from clutter of this type equivalent to a



one-to-two square meter contact has been measured; false tracks and erratic tracking of small contacts in the tide rip regions have been observed. Another problem area is antenna sidelobe returns from bridge piers, particularly from the San Francisco-Oakland Bay Bridge. These concentric rings of hits are not distributed in range and are thus not effectively eliminated by the delay line adaptive thresholding. The maneuver settling criterion has been effective in minimizing firm tracks from tide rips, ship wakes, and sidelobes. However, problems occur when detections in these clutter regions tend to interfere, via the track profile words, with existing real contacts passing through the clutter. The tracking of small maneuverable boats is disturbed the most because the higher  $\alpha$ ,  $\beta$  constants required result in greater noise susceptibility.

There are several regions of reduced radar visibility that affect tracking performance. The area extending radially beyond Alcatraz Island is a shadow zone for the YBI radar; medium and large contacts passing not too close to Alcatraz will continue to be tracked, but small boats will frequently be dropped and reacquired. A fairly large area just west of YBI is another region of

reduced coverage due to terrain on that side of the radar. Fortunately, this area is visible to the PTB radar, so a PTB mask enable zone is provided to give complementary coverage. In regions of mutual coverage, such as here and at the Golden Gate Bridge, the Traffic Analysis and Display (TAD) subsystem decides which of the two contact reports will be processed and displayed.

Perhaps the best method of depicting the problems that can appear due to clutter detections is to consider some typical measured results which compare the signal strength returned from various objects. These results are illustrated in Fig. 8. Actual detection thresholds in dBm for a given hit count will vary with the signal strength of the clutter causing the detections. The lowest line on the graph ( $-90$  dBm) is the radar Minimum Detectable Signal (MDS) for a signal-to-noise ratio of 0 dB. The detection threshold for each of the four selectable ungated hit count settings is given on the right side of the graph. It may be noted that the stronger tide rip returns are only a few dB below the Hovercraft (surface effects vehicle) and 40-foot boat, which have been measured at two-to-four square meters cross section.